

VICTORIA-B

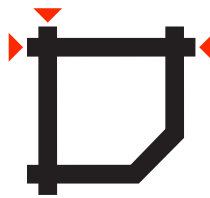

300 × 300 cm

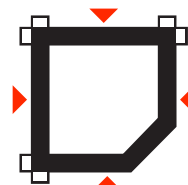

280 × 280 cm

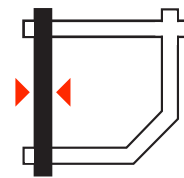

28 mm

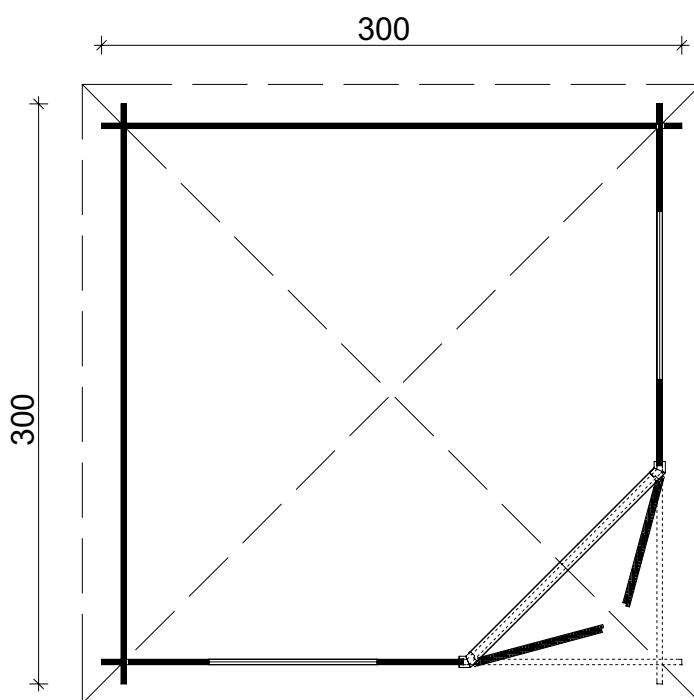
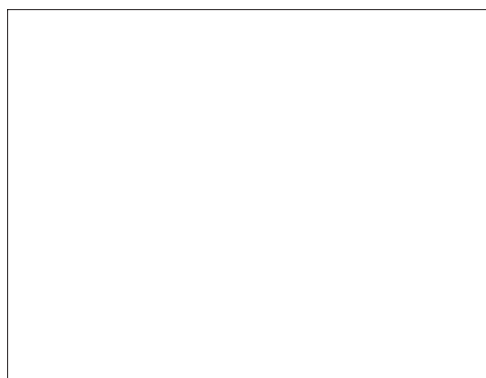



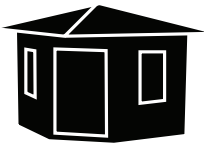







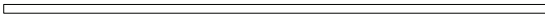
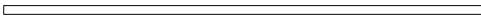



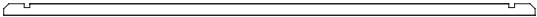

















- D Alle angegebenen Maße sind ca.-Maße
GB All dimensions are approximate !
NL Alle maten zijn circa maten
NO Alle vedlagte mål er ca !
E ¡Todas las dimensiones son aproximadas!
PT Todas as dimensões são aproximadas!
PL Wszystkie wymiary są przybliżone
EST Kõik mõõdud on ligilähedased.
IT Tutte le misure indicate sono circa
DK alle angivne mål er ca.-mål
S samtliga mått är ungefärliga
FR Toutes les dimensions fournies sont approximatives



VICTORIA - B 28 mm

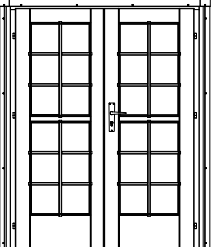
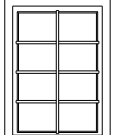
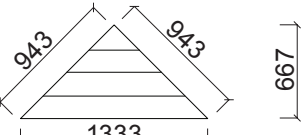

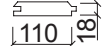

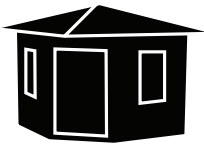









300 × 300 cm

| | |  mm |  mm |  × |
|----|---|---|--|---|
| 01 |  | 45 × 70 | 2750 | 5 |
| 02 |  | | 1794 | 1 |
| 03 |  | | 1390 | 2 |
| 04 |  | | 1844 | 1 |
| 05 |  | | 2209 | 1 |
| 06 |  |  57 | 3000 | 1 |
| 07 |  | | 1870 | 1 |
| 08 |  |  50 | 3000 | 2 |
| 09 |  |  107 | 3000 | 2 |
| 10 |  |  114 | 3000 | 37 |
| 11 |  | | 3000 | 1 |
| 12 |  | | 1929 | 1 |
| 13 |  | | 1870 | 1 |
| 14 |  | | 1870 | 1 |
| 15 |  | | 1870 | 10 |
| 16 |  | | 555 | 21 |
| 17 |  | 445 | 21 | |
| 18 |  | 28 × 120 | 1389 | 1 |
| 19 |  | 45 × 70 | 2318 | 4 |
| 20 |  | 45 × 60 | 1233 | 8(4+4) |
| 21 |  |  45 × 60 | 850 | 4 |
| 22 |  | | 902 | 8(4+4) |
| 23 |  |  | | 1 |
| 24 |  | 18 × 90 | 3250 | 4 |
| 25 |  | 1425 × 1900 mm | | 1 |
| 26 |  | 865 × 1210 mm | | 2(1+1) |
| 27 |  |  | | 1 |
| 28 |  |  110 18 | 3142 | 4 |
| 29 | | | 2938 | 4 |
| 30 | | | 2735 | 4 |

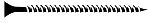

VICTORIA - B 28 mm

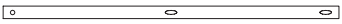
300 × 300 cm

| | |  mm |  mm |  × | | |
|----|---|--|--|---|------|---|
| 31 |  |  | 2532 | 4 | | |
| 32 | | | 2329 | 4 | | |
| 33 | | | 2125 | 4 | | |
| 34 | | | 1922 | 4 | | |
| 35 | | | 1718 | 4 | | |
| 36 | | | 1515 | 4 | | |
| 37 | | | 1312 | 4 | | |
| 38 | | | 1109 | 4 | | |
| 39 | | | 905 | 4 | | |
| 40 | | | 702 | 4 | | |
| 41 | | | 498 | 4 | | |
| 42 | | | 295 | 4 | | |
| 43 | | | 92 | 4 | | |
| 44 | | |  |  | 1855 | 1 |
| 45 | | | | | 1965 | 1 |
| 46 | | | | | 2075 | 1 |
| 47 | | | | | 2185 | 1 |
| 48 | 2295 | 1 | | | | |
| 49 |  | | 2405 | 1 | | |
| 50 | | | 2515 | 1 | | |
| 51 | | | 2625 | 1 | | |
| 52 | | | 2735 | -- | | |
| 53 | | | 2740 | 17+1 | | |
| 54 |  | 4,0×40/4,0×50 | | 130/470 | | |
| | | 5,0×70/6,0×140 | | 50/50 | | |
| 55 |  | 1,4 × 35 | | 25 | | |
| 56 |  |  | ca. 10,4 m | | | |
| 57 |  | | 2010 | 5 | | |
| 58 |  | M8×60 | | 15 | | |

TENE Kaubandus



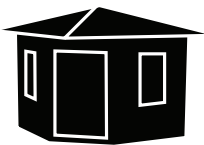

VICTORIA - B 28 mm

300 × 300 cm

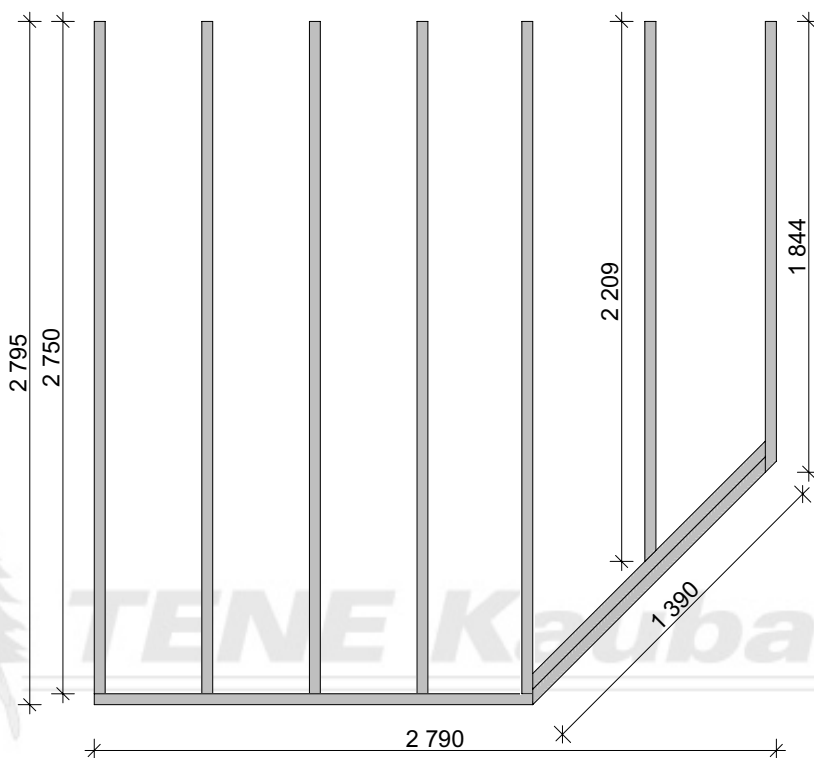
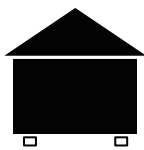

TENE Kaubandus

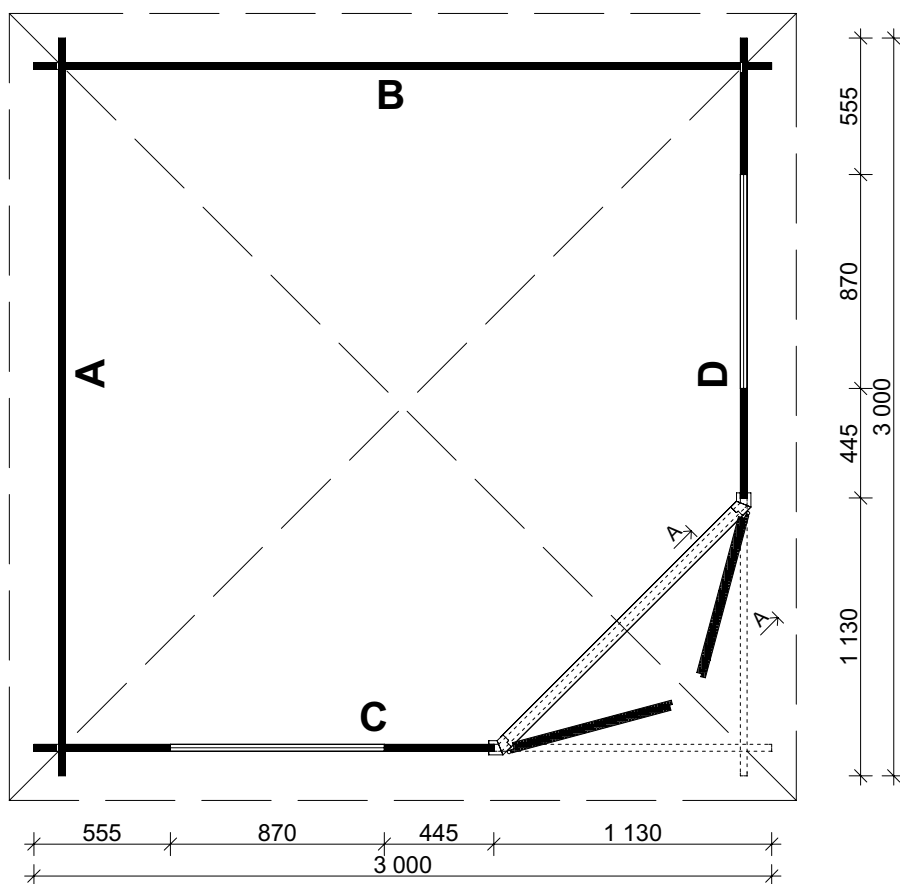
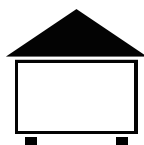

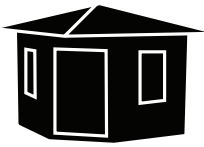

VICTORIA - B 28 mm

300 × 300 cm

A

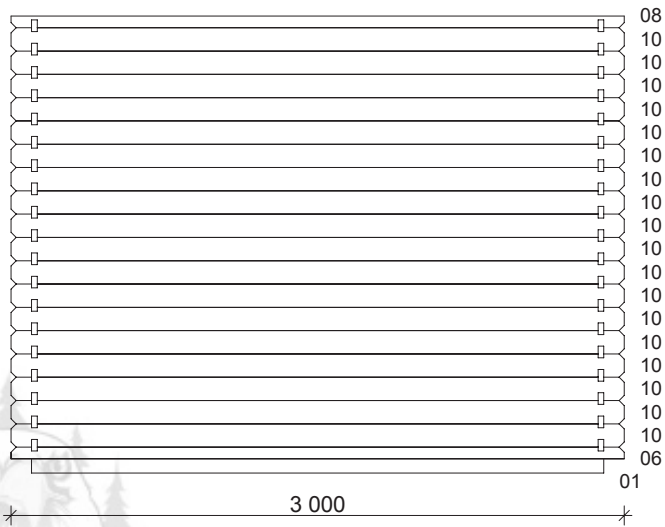

B

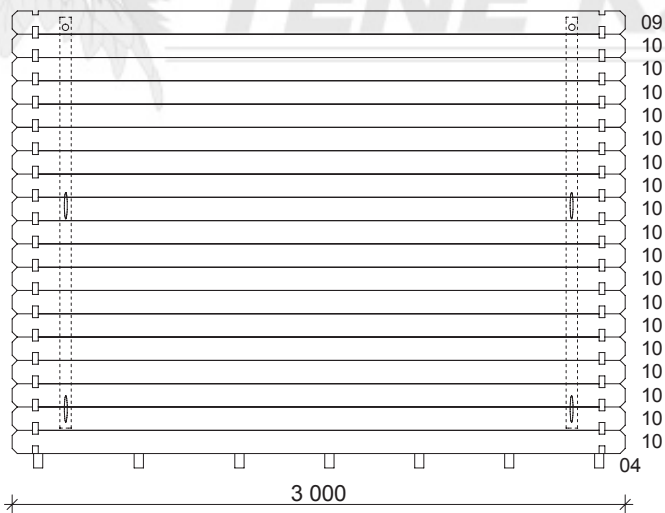

C

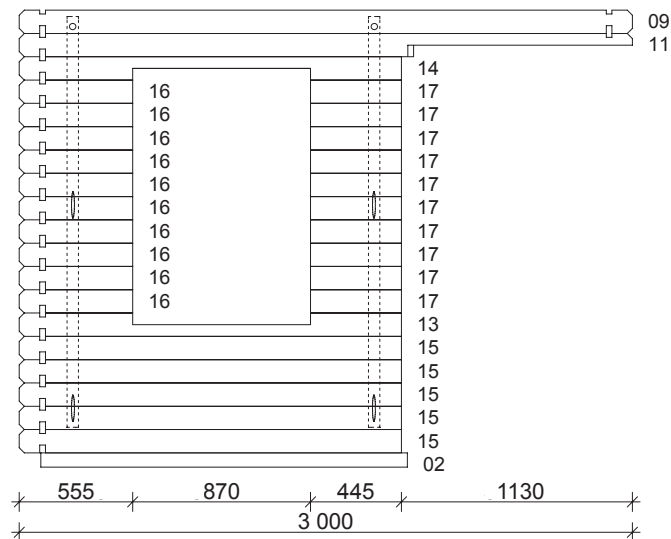

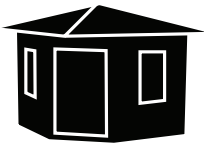

VICTORIA - B 28 mm

300 × 300 cm

D

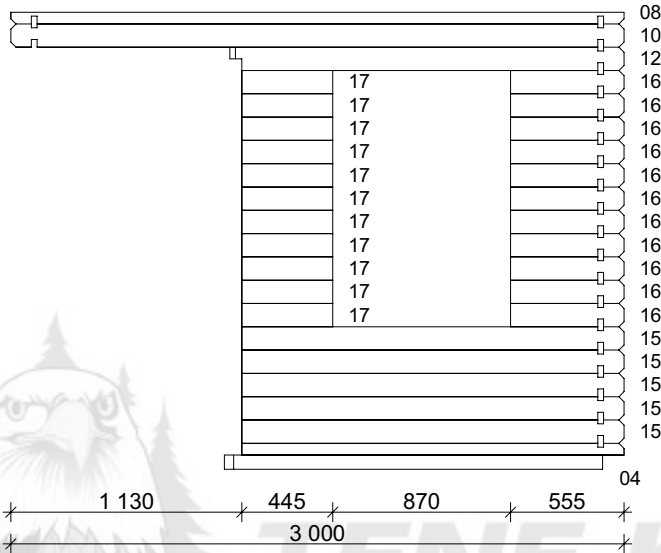

27

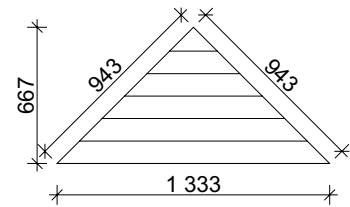

A - A

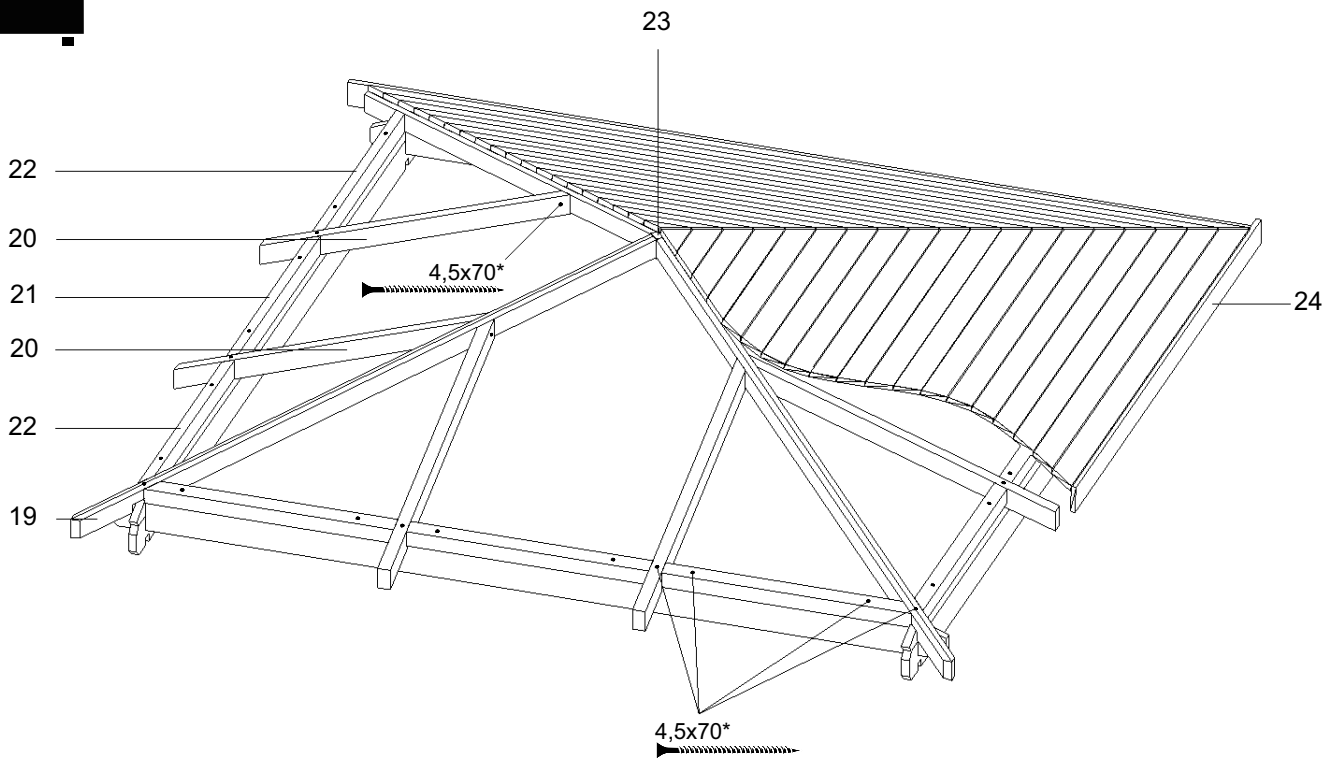
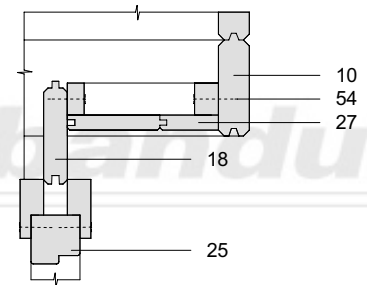

Doppeltür (Wand 28 mm)

| Nr | Beschreibung | Profil mm | Stück |
|----|------------------------------------|-----------|--------|
| 1 | Rahmen profil Links + Rechts | 99 x 82 | 1+1 |
| 2 | Rahmen profil Oberteil | 58 x 58 | 1 |
| 3 | Türschwelle | 28 x 58 | 1 |
| 4 | Wechselrahmen | 28 x 55 | -- |
| 5 | | | -- |
| 6 | | 28 x 70 | 1 |
| 7 | | | 1 |
| 8 | | | 2(1+1) |
| 9 | | | 2(1+1) |
| 10 | Edelstahlbedeckung für Türschwelle | | 1 |

A-A

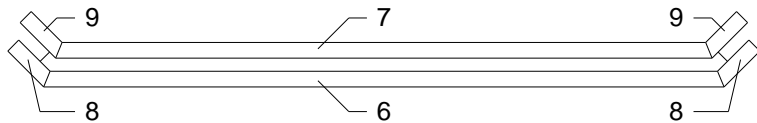

B-B

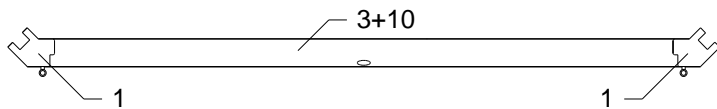

A ↓

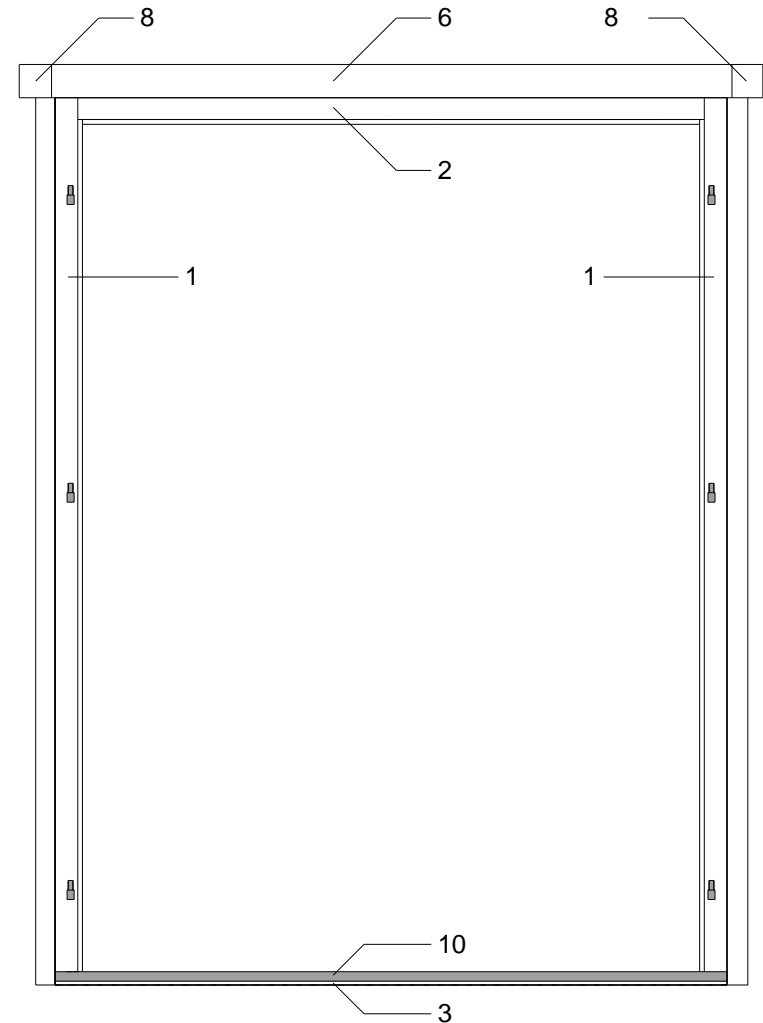

A ↓

B ↓

B ↓